



# HR100



## Long Range Motion and Presence Detection

### Dimensions

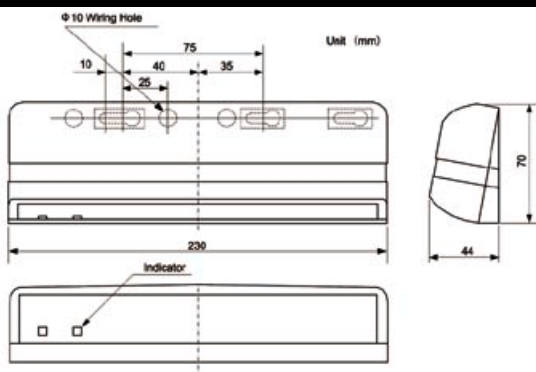

Model	HR100 ( Motion & Presence )
Detection Method	Active Infrared Detection
Installation Height	Max 2700 mm
Pattern Adjustments	Angle Adjustment: Inner 2 rows 0° to 8° in 5 steps Outer 2 rows 0° to 10° in 5 steps Pattern Depth: 1 to 4 rows
Presence Timer	2, 15, 60sec. & ∞ ( Inner 2 rows ) 2, 15, sec. ( Outer 2 rows )
Power Supply	12 to 24V AC or DC ±10%
Power Consumption	AC12V-1.5 VA , AC24V-2.0VA DC12V-80mA , DC24V-50mA
Output Contact	Relay contact : DC50V 0.1A (Resistance Load) Relay with "Fail Safe" function
Output Holding Time	Approx. 0.5 sec.
Indication	Power on: Green = ON Detecting: Red = ON Detecting Door: Orange = ON
Temperature Range	-20°C to +60°C
Weight	Approx. 250g
Color	Black
Accessories	Connection Cable, Mounting Template, Mounting Screws, Installation Instructions.

NOTE: Specifications may change without prior notice

### Detection Area

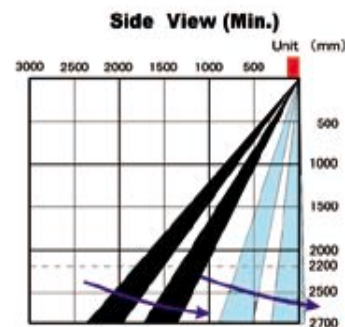
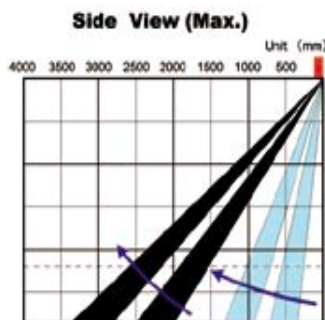
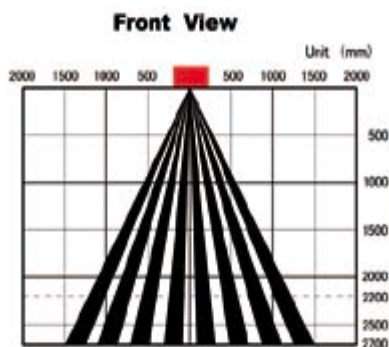

Outer 3 rows can be deleted one by one using dip switches.  
Outer 2 rows and inner 2 rows can be angled separately using mechanical lever

### Pattern Adjustment

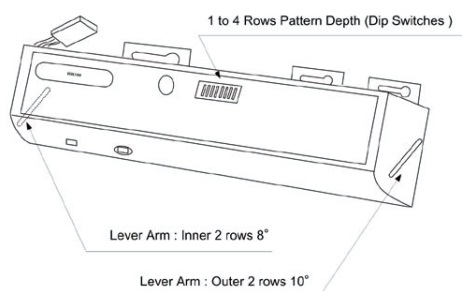

### Plan View (Max.)

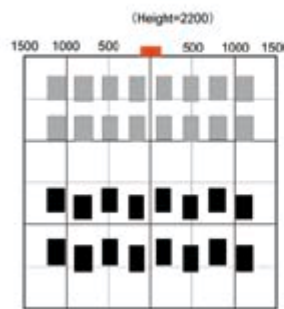

### Plan View (Min.)

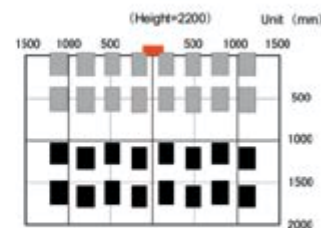

**HOTRON IRELAND LTD.**  
37 Dublin Street (2nd Floor), Carlow, Ireland.  
Tel: +353-(0)503-40345 · Fax: +353-(0)503-40543  
URL: <http://www.hotron.com>

**HOTRON CO. LTD.**  
1-11-26 Hyakunin-Cho Shinjuku-ku, Tokyo 169-0073, Japan.  
Tel: +81-3-5330-9221 · Fax: +81-3-5330-9222  
URL: <http://www.hotron.co.jp>

