

OA-AXIS II

5015032 JUN 2016

MANUFACTURER'S STATEMENT

Read this operation manual carefully before use to ensure proper operation of this product. Failure to read this operation manual may cause improper operation and may result in serious injury or death of a person. The meanings of the symbols are as follows.

	WARNING	Disregard of warning may cause the improper operation causing death or serious injury of person.
	CAUTION	Disregard of caution may cause the improper operation causing injury of person or damage to objects.
	NOTE	Special attention is required to the section of this symbol.

- NOTE**
- This sensor is a non-contact switch intended for header mount / wall mount of an automatic door. Do not use for any other applications. This sensor cannot be used for industrial doors or shutters, when used, proper operation and safety cannot be guaranteed.
 - When setting the sensor's detection area, make sure there is no traffic around the installation site.
 - Before turning the power ON, check the wiring to prevent damage or malfunction of equipments that are connected to the sensor.
 - Only use the sensor as specified in the operation manual provided.
 - Be sure to install the sensor in accordance with the local laws and standards of the country in which the sensor is installed.
 - Before leaving the job site make sure that the sensor is operating properly and instruct the building owner/operator on proper operation of the door and the sensor.
 - The sensor setting can only be changed by an installer or service engineer. When changed, register the changed setting and dates in the maintenance logbook accompanying the door.

	WARNING	Do not wash, disassemble, rebuild or repair the sensor, otherwise it may cause electric shock or breakdown of equipments.
Danger of electric shock.		

- NOTE**
- The following conditions are not suitable for the sensor installation.
- Fog or exhaust emission around the door.
 - Wet floor
 - Vibrating header or mounting surface.
 - Moving objects or a heating radiator in the detection area.
 - Highly reflecting floor or the presence of highly reflecting objects around the door.

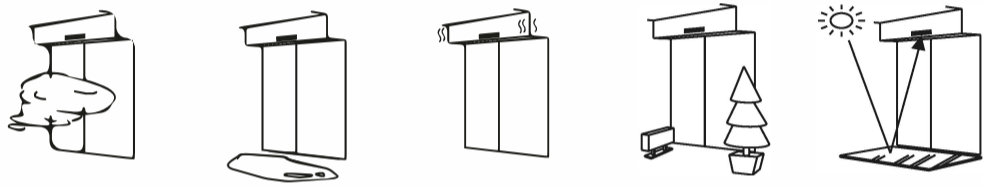

SPECIFICATIONS

Model	: OA-AXIS II	Output	: OA-AXIS II
Cover color	: Silver / Black		
Mounting height	: 2.0 (6'7") to 3.5m (11'5")	1st to 3rd rows / Form C relay	50V 0.3A Max. (Resistance load)
Detection area	: See DETECTION AREA	3rd to 5th rows / Form C relay	50V 0.3A Max. (Resistance load)
Detection method	: Active Infrared Reflection		
Depth angle	: 1st to 3rd rows / -6° to +6°	Output hold time	: Approx. 0.5sec.
adjustment	4th and 5th rows / +26° to +44°	Response time	: < 0.3sec.
Power supply	: 12 to 24VAC (±10%)	Operating temperature	: -20 to +55°C (-4 to 131°F)
12 to 30VDC (±10%)		IP rate	: IP44
Power consumption	: OA-AXIS II < 4VA	Weight	: 320g (11.2oz)
Operation LED	: Green / Stand-by	Accessories	: 1 Cable 3m (9'10")
	Blinking Red / 1st row detection		1 Operation manual
	Red / 2nd row detection		2 Mounting screws
	Orange / 3rd to 5th rows detection		1 Mounting template
			1 Area adjustment tool

NOTE The specifications herein are subject to change without prior notice due to improvements.

OUTER DIMENSIONS AND PART NAMES

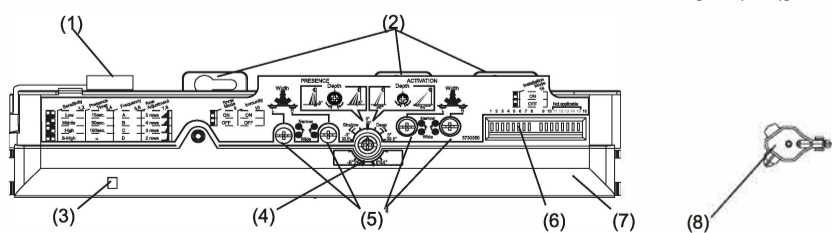
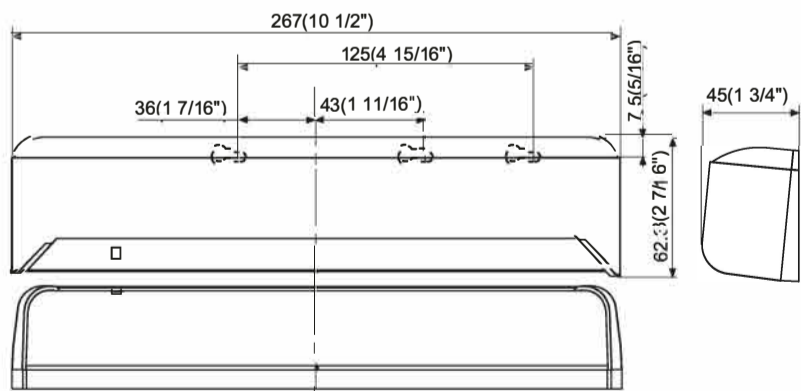

- Connector
- Mounting holes
- Operation LED
- Depth angle adjustment screw
- Width adjustment screws
- Dipswitches
- Detection window
- Area adjustment tool

DETECTION AREA

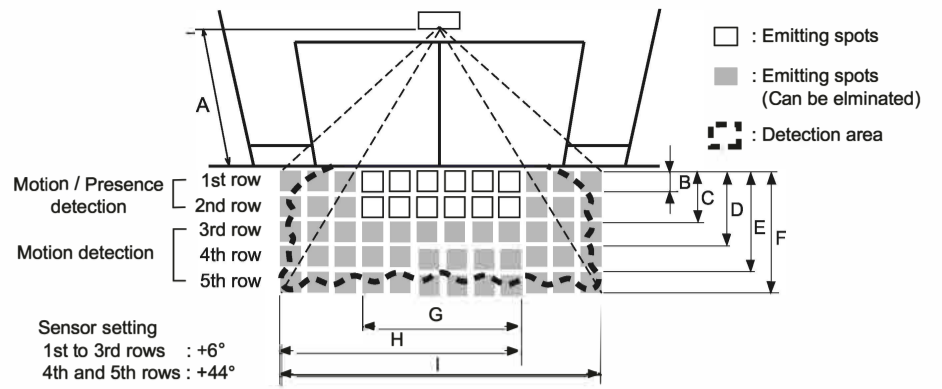

[m(feet,inch)]

A	2.20 (7'3")	2.50 (8'2")	2.70 (8'10")	3.00 (9'10")	3.50 (11'6")
B	0.14 (6")	0.16 (6")	0.18 (7")	0.20 (8")	0.23 (9")
C	0.42 (1'5")	0.48 (1'7")	0.52 (1'8")	0.58 (1'11")	0.67 (2'2")
D	0.82 (2'8")	0.93 (3'1")	1.00 (3'3")	1.10 (3'7")	1.30 (4'3")
E	1.35 (4'5")	1.54 (5'1")	1.66 (5'5")	1.85 (6'1")	2.16 (7'1")
F	1.90 (6'3")	2.17 (7'1")	2.34 (7'8")	2.60 (8'6")	3.03 (9'11")
G	1.33 (4'4")	1.51 (4'11")	1.63 (5'4")	1.81 (5'11")	2.11 (6'11")
H	2.05 (6'9")	2.32 (7'7")	2.51 (8'3")	2.79 (9'2")	3.26 (10'8")
I	2.78 (9'1")	3.15 (10'4")	3.40 (11'2")	3.79 (12'5")	4.42 (14'6")

NOTE The actual detection area may become smaller depending on the ambient light, the color / material of the object or the floor as well as the entry speed of the object.

*The values of the chart above is of the emitting spots, but not of the detection area.

INSTALLATION

- Affix the mounting template at the desired mounting position.
- Drill two mounting holes of $\phi 3.4\text{mm}$ ($\phi 1/8"$).
- To pass the cable through to the header, drill a wiring hole of $\phi 8\text{mm}$ ($\phi 5/16"$).
- Remove the mounting template.
- Remove the housing cover. Attach the sensor to the mounting surface with two mounting screws.

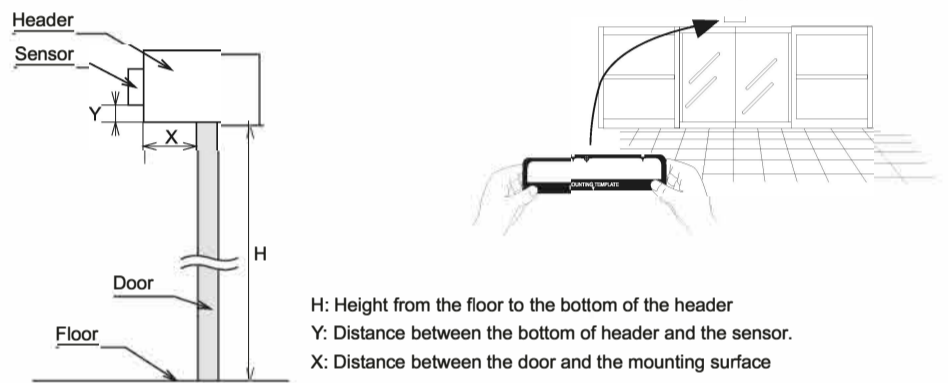

Maximum mounting distance (Y) [m (feet,inch)]

X \ H	2.00 (6'7")	2.20 (7'2")	2.50 (8'2")	3.00 (9'10")
0	No limit			
0.05 (2")	0.20 (8")	0.20 (8")	0.20 (8")	0.20 (8")
0.10 (4")	0.20 (8")	0.20 (8")	0.20 (8")	0.20 (8")
0.15 (6")	0.13 (5")	0.15 (6")	0.17 (7")	0.20 (8")
0.20 (8")	-	0.11 (4")	0.13 (5")	0.15 (6")
0.25 (10")	-	-	-	0.12 (5")
0.30 (12")	-	-	-	-

	CAUTION	Make sure to affix the mounting template as described in the above chart. Otherwise, it can be dangerous since there may be no presence detection area around the threshold. Install the sensor as low as possible on the header.
Risk of getting caught.		

NOTE The sensor mounting position may be limited depending on the header thickness and the mounting height.

- Wire the cable to the door controller properly as shown in the drawing below.

OA-AXIS II



Grey	Power supply	
Grey	12 to 24VAC ±10%	
Grey	12 to 30VDC ±10%	
White	Common (COM.)	3rd to 5th * rows output
Yellow	Normally open (N.O.)	
Green	Normally closed (N.C.)	
White Str.	Common (COM.)	1st to 3rd * rows output
Yellow Str.	Normally open (N.O.)	
Green Str.	Normally closed (N.C.)	

*The outputs from the 3rd row overlaps.

	WARNING	Before starting the procedure, ensure that the power is turned OFF. When passing through the cable to the hole, make sure not to tear the shield, otherwise it may cause electric shock or breakdown of the sensor.
Danger of electric shock.		

- Plug the connector of the sensor.
- Supply power to the sensor. Adjust the detection area and set the dipswitches. (See **ADJUSTMENTS**)

NOTE Make sure to connect the cable correctly to the door controller before turning the power ON. When turning the power ON or after adjusting the settings, do not enter the detection area for more than 10 seconds in order to enable the presence detection. Do not touch the dipswitches before turning the power ON, otherwise an error occurs. After changing the dipswitch and/or potentiometer settings, make sure to push the function switch for 2 seconds.

- Place the housing cover. If wiring is to be exposed, break the knockout.

	WARNING	Do not use the sensor without the cover. When using the cable knockout, install the sensor indoors or use the rain-cover (Separately available) otherwise electric shock or breakdown of the sensor may occur.
Danger of electric shock.		

ADJUSTMENTS

1 Area depth angle adjustment

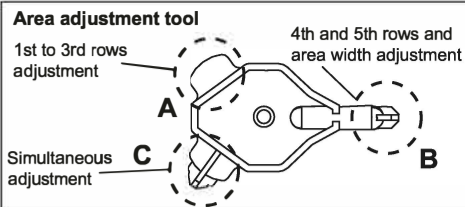
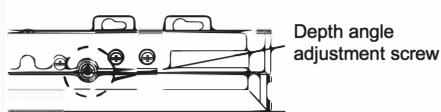

The detection area depth can be changed by the area adjustment tool.
When adjusting the 1st to 3rd rows close to the door, follow 3-7. Installation mode.

1-1. Independent adjustment

1st to 3rd rows

Depth angle adjustment screw for 1st to 3rd rows

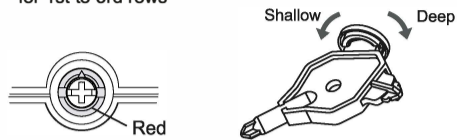

Use the area adjustment tool (A) as shown above and change the depth of the detection area by turning the depth angle adjustment screw.

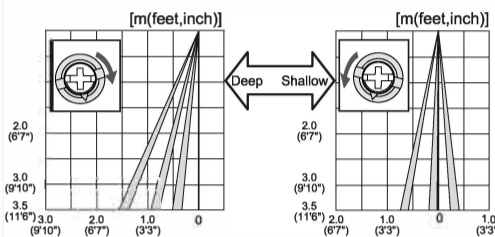

Check the area position with Red LED of the Operation LED using a tool such as a reflecting mirror.

NOTE Make sure the detection area does not overlap with the door / header, otherwise ghosting / signal saturation may occur. Do not place any highly reflecting objects in the detection area, otherwise signal saturation may occur.

4th and 5th rows

Depth angle adjustment screw for 4th and 5th rows

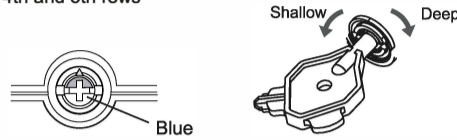

Use the area adjustment tool (B) as shown above and change the depth of the detection area by turning the depth angle adjustment screw.

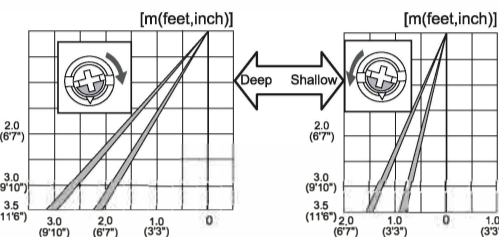

REFERENCE Area depth adjustment with INFRARED FINDER (Separately available)

- Turn the depth adjustment screw to the right (Deep) to place the area most away from the door.
- Set INFRARED FINDER sensitivity to "H" (High) and place it on the floor as shown below.

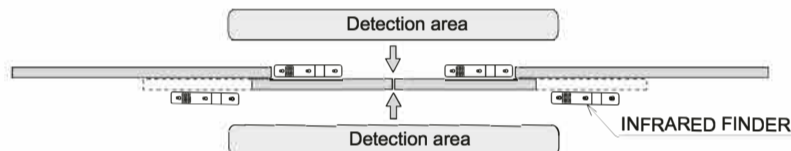

- Turn the depth adjustment screw to the left (Shallow) until the emitting area is placed at the position where INFRARED FINDER is in the low detection status (Slow Red blinking).

1-2. Simultaneous adjustment

For the simultaneous adjustment of 1st to 5th rows, use the adjustment tool (C).

2 Width detection area adjustment

1st to 3rd rows

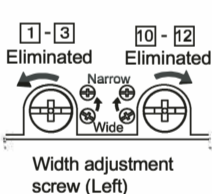

4th and 5th rows

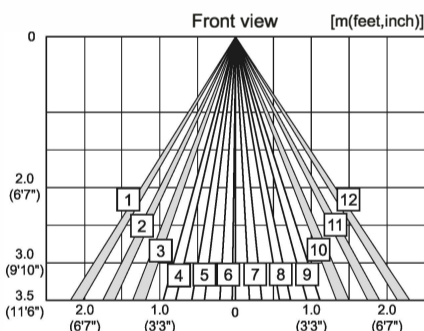
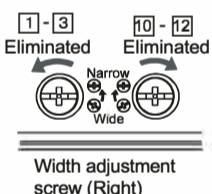

NOTE The actual detection area may become smaller depending on the ambient light, the color / material of the object and the floor as well as the entry speed of the object.

3 Dipswitch settings

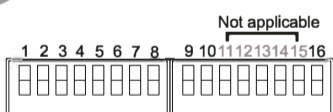

- | | |
|--------------------------------|---------------------------|
| 1,2 : Sensitivity | 9 : Snow mode |
| 3,4 : Presence detection timer | 10 : Immunity |
| 5,6 : Frequency | 11 to 15 : Not applicable |
| 7,8 : Row adjustment | 16 : Installation mode |

3-1. Setting the sensitivity

Normally set to "Middle". "Low" decreases the sensitivity and "High / S-High" increases the sensitivity.



3-2. Setting the presence detection timer

The 1st and 2nd rows have the presence detection function. The presence detection timer can be selected from 4 settings.



NOTE To enable the presence detection, do not enter the detection area for 10 seconds after setting the timer.

3-3. Setting the frequency

When using more than one sensor close to each other, set the different frequency for each sensor by combining dipswitch 5 and 6.

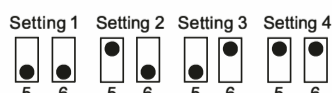

3-4. Setting the area depth

The 5th, 4th, and 3rd rows can be eliminated by combining dipswitches 7 and 8.

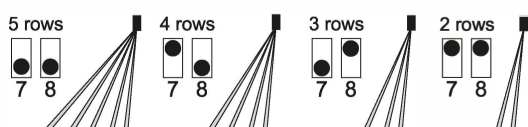

*When 2rows setting is selected, only the presence detection area remains.

NOTE Always check the area according to the expected entry speed and determine the appropriate number of rows. When setting motion and motion / presence detection area separately, make sure that there is no gap between two areas.

3-5. Setting the snow mode

Set this switch to ON, if the sensor is used in a region with snow.

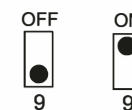

3-6. Setting the immunity

Set this switch to ON, when less influence by the header vibration is required.

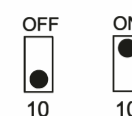

3-7. Installation mode

Use this switch to ON when adjusting the presence detection area close to the door face.

- * During the installation mode, only the 1st row remain.
- * Door open state
- * Operation LED glows yellow.

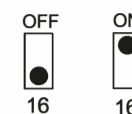

CHECKING

Check the operation according to the chart below.

- | | |
|-----------------|----------------------|
| ① White : COM. | ④ White Str. : COM. |
| ② Yellow : N.O. | ⑤ Yellow Str. : N.O. |
| ③ Green : N.C. | ⑥ Green Str. : N.C. |

Entry	Power off	Outside of detection area	Entry into 4th or 5th row	Entry into 3rd row	Entry into 2nd row	Entry into 1st row
Status	-	Stand-by	Motion detection active	Motion/Presence detection active	Presence detection	
Operation LED	None	Green	Orange		Red	Blinking Red
OA-AXIS II						
Output from 1st to 3rd rows*	④ ⑤ ⑥	④ ⑤ ⑥	④ ⑤ ⑥	④ ⑤ ⑥	④ ⑤ ⑥	④ ⑤ ⑥
Output from 3rd to 5th rows*	① ② ③	① ② ③	① ② ③	① ② ③	① ② ③	① ② ③

*The outputs from the 3rd row overlaps.

INFORM BUILDING OWNER / OPERATOR OF THE FOLLOWING ITEMS

WARNING

- Always keep the detection window clean. If dirty, wipe the window lightly with a damp cloth. (Do not use any cleaner or solvent.)
- Do not wash the sensor with water.
- Do not disassemble, rebuild or repair the sensor yourself, otherwise electric shock may occur.
- When an operation LED blinks green, contact your installer or service engineer.
- Always contact your installer or service engineer when changing the settings.
- Do not paint the detection window.

NOTE

- When turning the power ON, always walk-test the detection area to ensure proper operation.
- Do not place any objects that move or emit light in the detection area. (e.g. Plant, illumination, etc.)

TROUBLESHOOTING

Problem	Operation LED	Possible cause	Possible countermeasures
Door does not open when a person enters the detection area.	None	Power supply voltage. Wrong wiring or connection failure.	Set to the stated voltage. Check the wires and connector.
	Unstable	Wrong detection area positioning.	Check ADJUSTMENTS 1 & 2 .
		Sensitivity is too low.	Set the sensitivity higher.
		Short presence detection timer. Dirty detection window.	Set the presence detection timer longer. Wipe the detection window with a damp cloth. (Do not use any cleaner or solvent.)
Door opens when no one is in the detection area. (Ghosting)	Unstable	Vibration of the header.	Set the sensitivity lower or the immunity to ON.
		Water drops on the detection window.	Use the rain-cover (Separately available). Or install in a place keeping the waterdrops off.
		The detection area overlaps with that of another sensor.	Check ADJUSTMENTS 3-3 .
		The detection area overlaps with the door / header.	Adjust the detection area to "Deep" (Outside).
		Reflecting objects in the detection area. Or reflecting light on the floor.	Remove the objects.
		Sensitivity is too high.	Set the sensitivity lower.
		It snows and pours.	Set the snow mode to ON.
		Objects that move or emit light in the detection area. (Ex.Plant, illumination,etc.)	Remove the objects.
		Wet floor.	Check the installation condition referring to INSTALLATION on the reverse side.
		The exhaust emission or fog penetrate into the detection area.	
Door remains open	Red or Orange	Sudden change in the detection area.	Check ADJUSTMENTS 3-1 & 3-2 . If the problem still persists, hard-reset the sensor. (Turn the power OFF and ON again.)
		Proper	Wrong wiring or connection failure.
	Twice Green blinking	The relay is reaching the end of its life cycle.	Contact your installer or the sales engineer.
		Slow Green blinking	Signal saturation
			The detection area overlaps with the door / header.
Door remains closed	Proper	Wrong wiring or connection failure.	Check the wires and connector.

Manufacturer

OPTEX Co.,LTD.
5-8-12 Ogoto Otsu 520-0101, Japan
TEL.: +81(0)77 579 8700 FAX.: +81(0)77 579 7030
WEBSITE: www.optex.co.jp/as/eng/index.html

European Subsidiary

OPTEX Technologies B.V.
Henricuskade 17, 2497 NB The Hague, The Netherlands
TEL.: +31(0)70 419 41 00 FAX.: +31(0)70 317 73 21
E-MAIL: info@optex.eu WEBSITE: www.optex.eu